

Unsere Katalog Serie

Implantologie

Wash Trays



KFO-Katalog

Hauptkatalog

NEW EDITION 2016



Dentalinstruments Germany



MICROTOOLS

┆ 3,0 mm

┆ 4,5 mm

┆ 3,0 mm

┆ 3,0 mm



MICRO HEBER FÜR FEINCHIRURGIE



Micro
16 cm
Ref. 13-3MT

Micro
16 cm
Ref. 13-5MT



distal

MICRO SYNDESMOTOME

Micro
16 cm
Ref. 13-8MT



mesial

Micro
16 cm
Ref. 13-9MT

ZAHNZANGEN



OK Schneidezähne
(Fig. 1)
Ref. 11-1

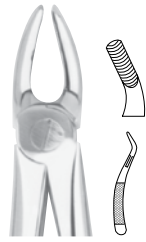

OK Prämolaren
(Fig. 7)
Ref. 11-7

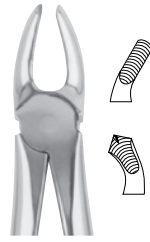

OK Molaren
(Fig. 17)
Ref. 11-17

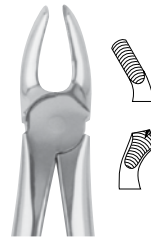

OK Molaren links
(Fig. 18)
Ref. 11-18

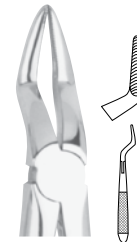

OK Wurzeln
(Fig. 51A)
Ref. 11-51A

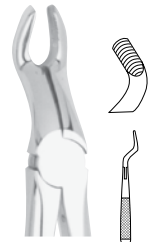

OK Molaren
(Fig. 67A)
Ref. 11-67A



UK Prämolaren
(Fig. 13)
Ref. 11-13

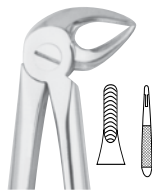

UK Wurzeln
(Fig. 33)
Ref. 11-33



UK Molaren
(Fig. 22)
Ref. 11-22



UK Molaren
(Fig. 73)
Ref. 11-73

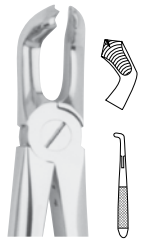

UK dritte Molaren
(Fig. 79)
Ref. 11-79

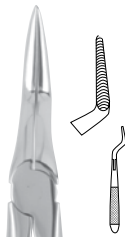

OK Wurzeln
(Fig. 151)
Ref. 11-151



OK Wurzeln
(Fig. 152)
Ref. 11-152



UK Wurzeln
(Fig. 136)
Ref. 11-136



UK Wurzeln
(Fig. 145)
Ref. 11-145



OK Wurzeln
(Fig. 49)
Ref. 11-49



UK Wurzeln
(Fig. 46)
Ref. 11-46



OK dritte Molaren
(Fig. 67N)
Ref. 11-67N

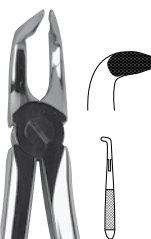

UK dritte Molaren
(Fig. 79N)
Ref. 11-79N



OK Prämolaren
(Fig. 7N)
Ref. 11-7N



UK Prämolaren
(Fig. 36N)
Ref. 11-36N

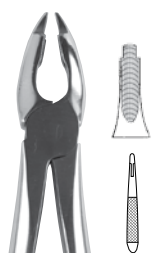

OK Schneidezähne
(Fig. 34A)
Ref. 11-34A

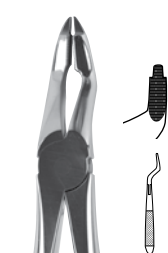

OK Wurzeln
(Fig. 331)
Ref. 11-331

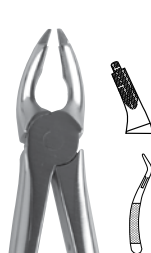

OK Prämolaren
(Fig. 35A)
Ref. 11-35A



UK Prämolaren
(Fig. 336)
Ref. 11-336



UK Prämolaren
(Fig. 36A)
Ref. 11-36A

WURZELHEBER



Wurzelheber Bein

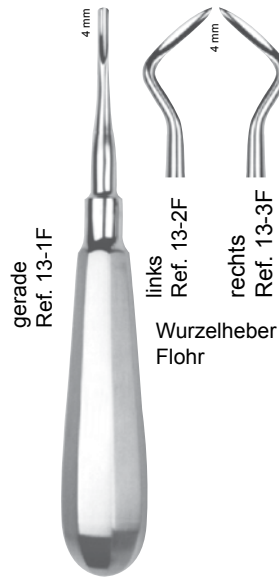
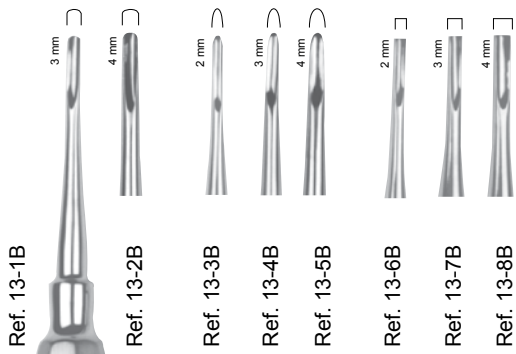

Wurzelheber Flohr

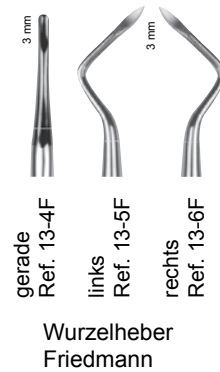
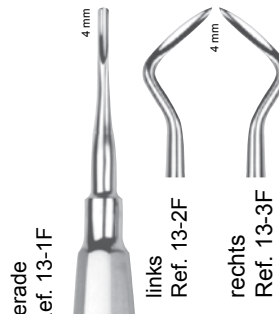

Wurzelheber Friedmann



Krallenheber

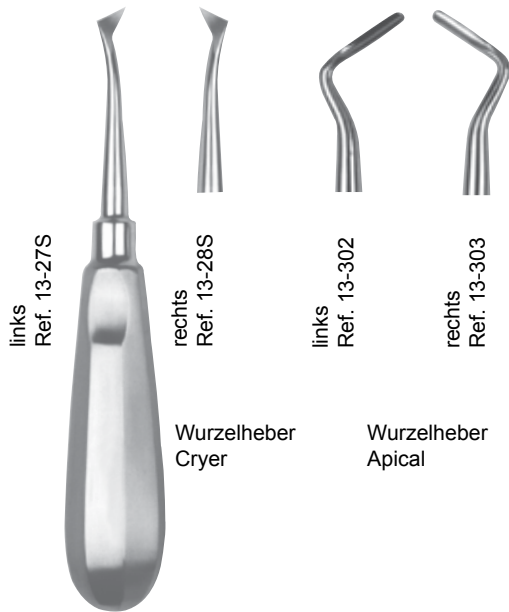

Wurzelheber Cryer

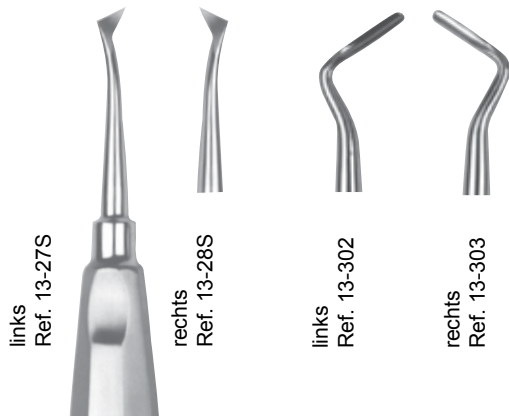

Wurzelheber Apical



Ref. 13-1 LX gerade Ref. 13-5 LX gebogen

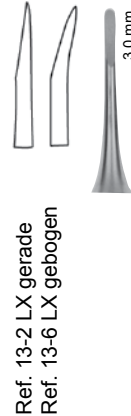

Ref. 13-2 LX gerade Ref. 13-6 LX gebogen

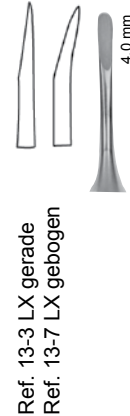

Ref. 13-3 LX gerade Ref. 13-7 LX gebogen

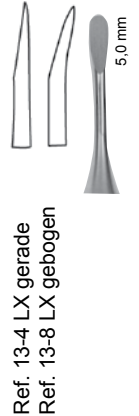

Ref. 13-4 LX gerade Ref. 13-8 LX gebogen

Wurzelsplitterheber

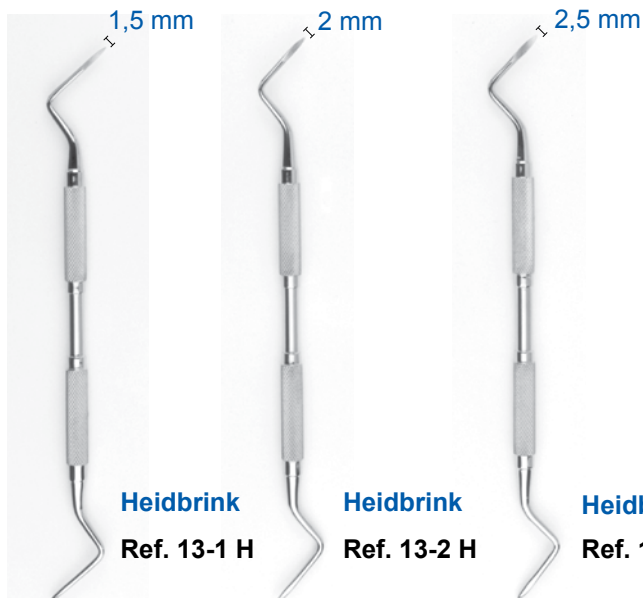

Heidbrink
Ref. 13-1 H

Heidbrink
Ref. 13-2 H

Heidbrink
Ref. 13-3 H

Syndesmotome - Chompret



Ref. 13-35

Ref. 13-35A

Ref. 13-35B



WANGENHALTER

WUNDSPREIZER

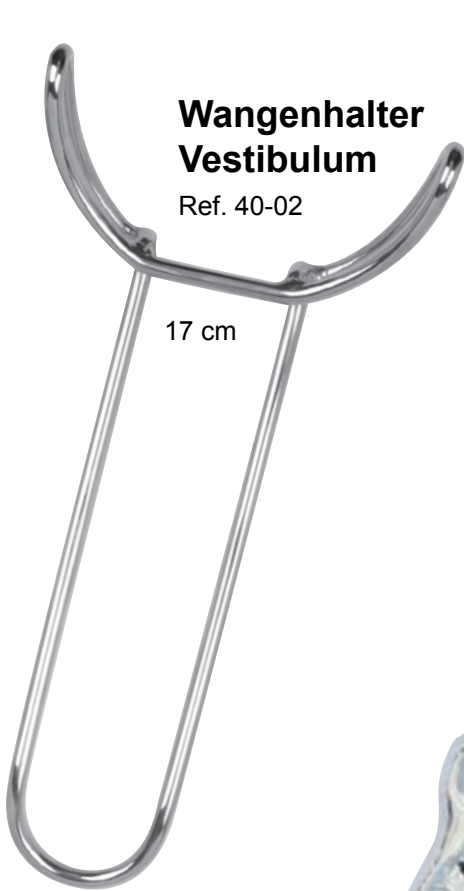

NEW

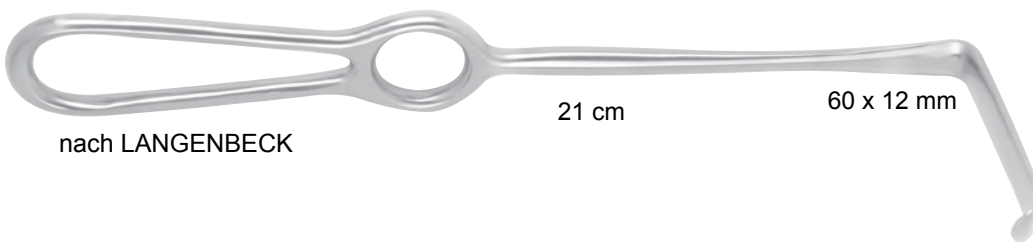
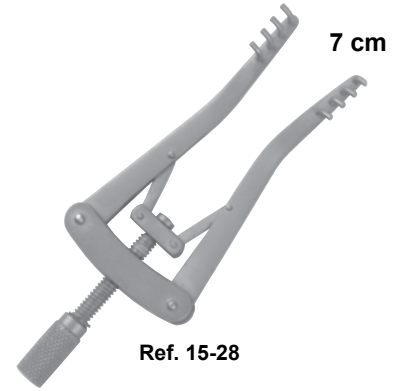
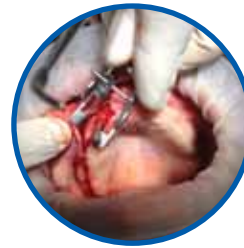

KRONENSPREIZER



Kronenaufbieger



Universal

Ref. 30-8B

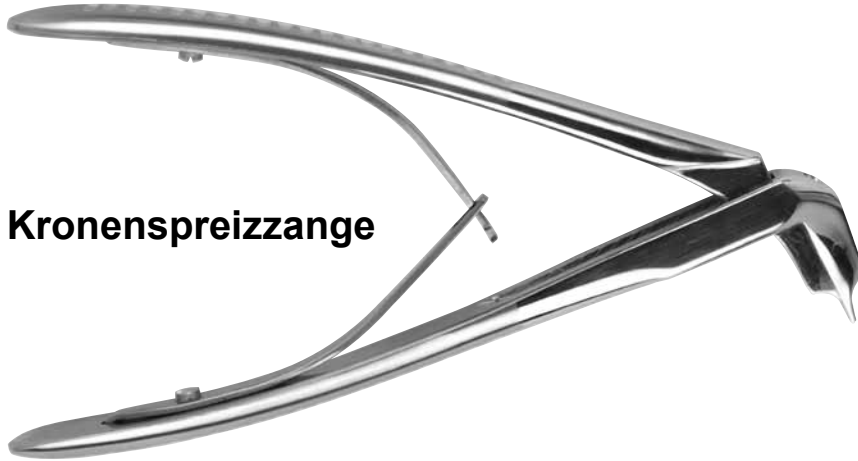

Kronenspreizzange

Ref. 30-8D

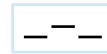

SILIKONSCHÄLMESSER



15 cm

Ref. 35-01

WURZELSPITZEN- UND HOHLMEISSELZANGEN

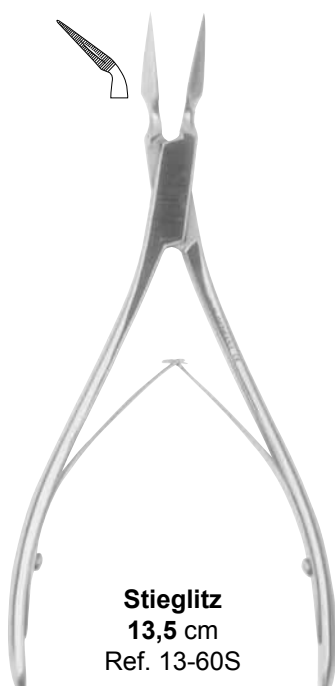

Stieglitz
13,5 cm
Ref. 13-60S



Universal
15 cm
Ref. 13-75TC

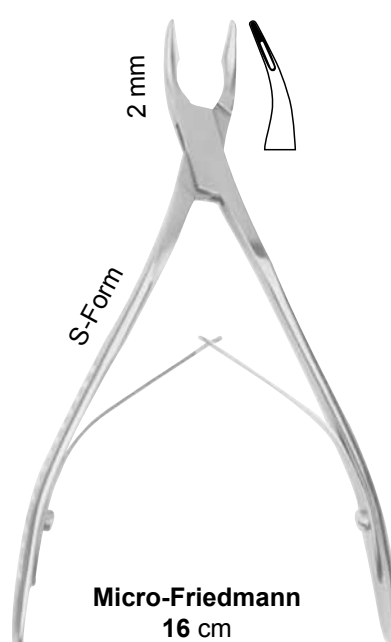



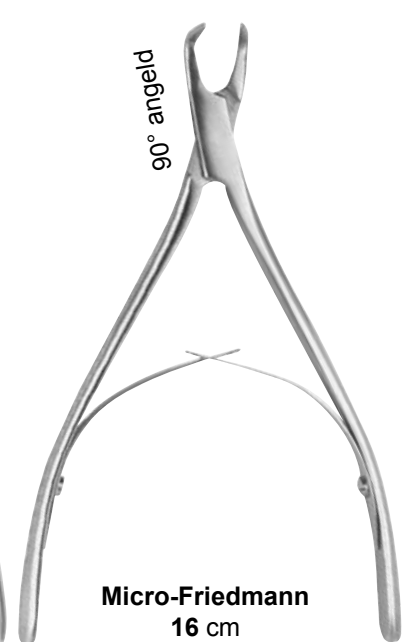









Micro-Friedmann
16 cm
Ref. 14-2



Micro-Friedmann
16 cm
Ref. 14-2 B

PINZETTEN

15 cm		Collegepinzette		Ref. 22-3
16 cm		Meriampinzette		Ref. 22-1
18 cm		Micro-Pinzette Gomel	chirurgisch gerade	Ref. 22-30
18 cm		Micro-Pinzette Gomel	chirurgisch gebogen	Ref. 22-31
18 cm		Micro-Pinzette Gomel	anatomisch gerade	Ref. 22-32
18 cm		Micro-Pinzette Gomel	anatomisch gebogen	Ref. 22-33
12 cm		Adson-Pinzette	anatomisch	Ref. 22-14
12 cm		gerade Adson-Pinzette	chirurgisch	Ref. 22-15
12 cm		gebogen Adson-Pinzette	chirurgisch	Ref. 22-16A
12 cm		Micro-Adson-Pinzette	ultra fein	Ref. 22-15A
15 cm		De Bakey	atraumatisch	Ref. 22-35
15 cm		Artikulationspinzette Miller		Ref. 22-23
15 cm		Artikulationspinzette Miller	starke Spitzen	Ref. 22-23A
		Collegepinzette		Ref. 22-26

SKALPELLGRIFFE



Rundskalpellgriff gebogen

Ref. 30-12A



Rundskalpellgriff-ERGOFORM

Ref. 40-27



Skalpellgriff mit Skalierung

Ref. 30-9A

MUNDSPIEGELGRIFFE

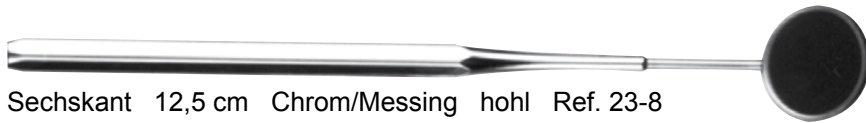

Sechskant 12,5 cm Chrom/Messing hohl Ref. 23-8

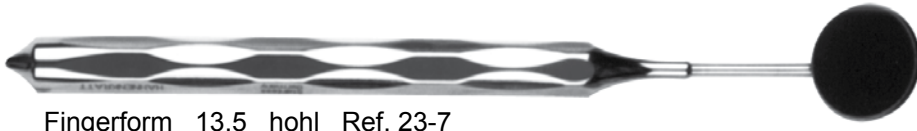

Fingerform 13,5 hohl Ref. 23-7



Rundgriff gerändlet 12 cm solide Ref. 23-10

SPIEGEL



Mundspiegel - Ø 24mm
- Rhodium
- plan
- doppelseitig
Ref. 23-6A

RASPATOREN

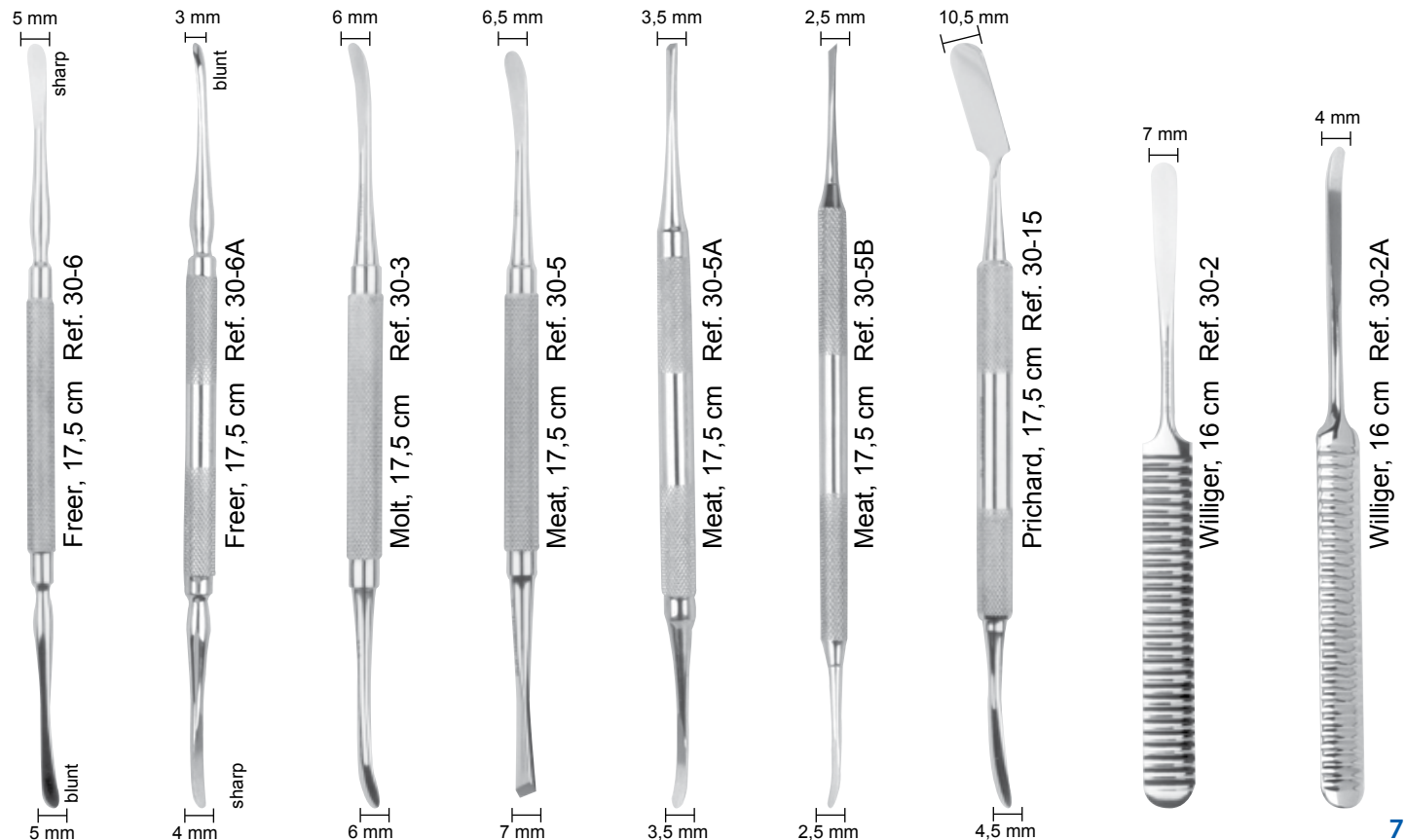

FÜLLUNGSTRUMENTE

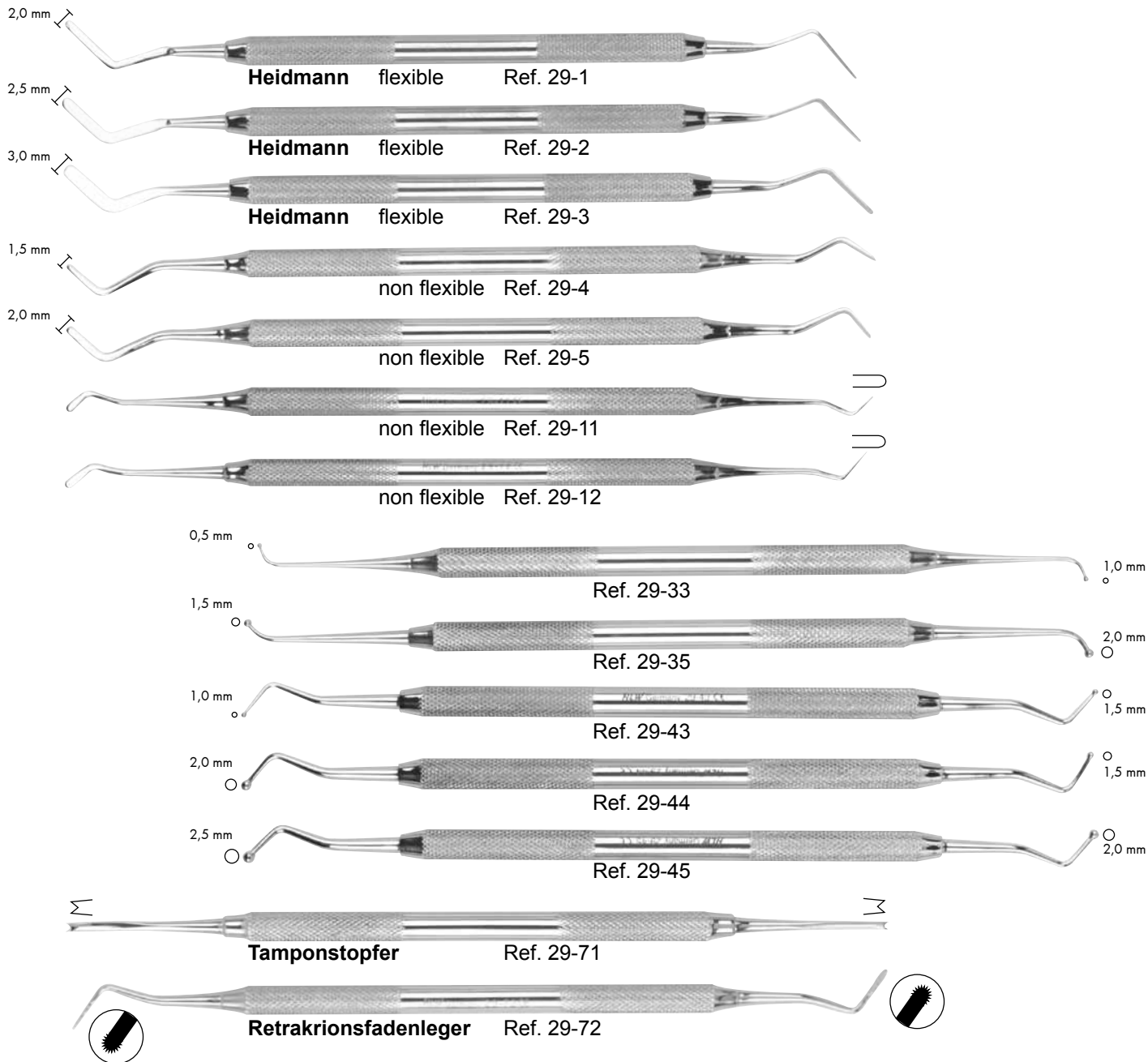

EXCAVATOREN

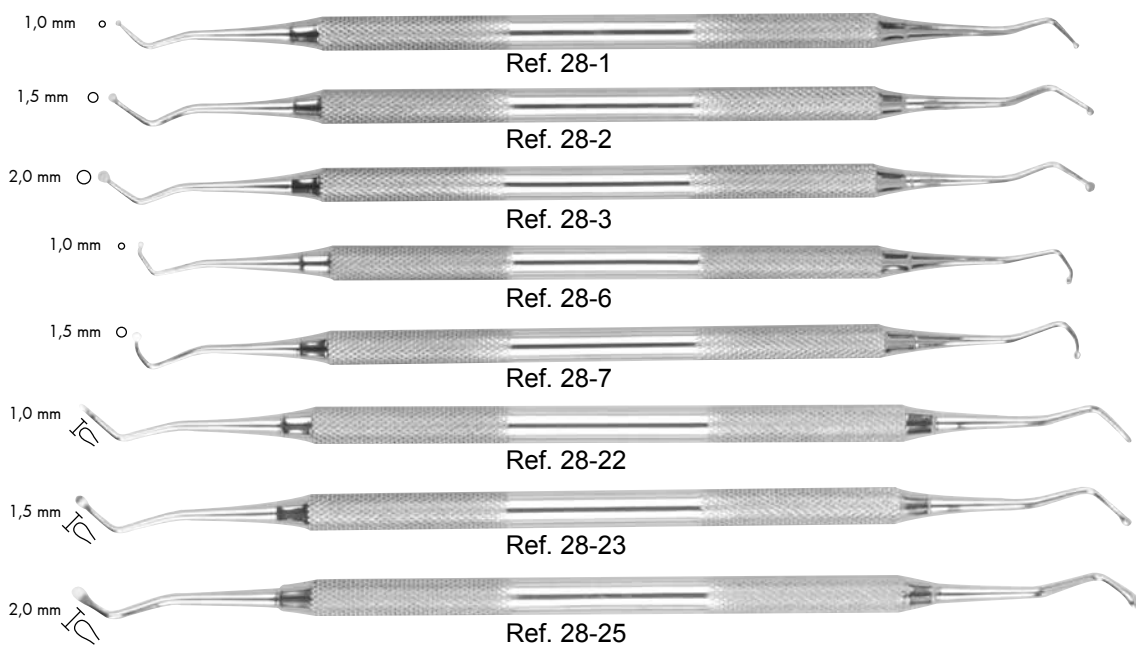

TITANNITRID INSTRUMENTE



P.A. SONDEN

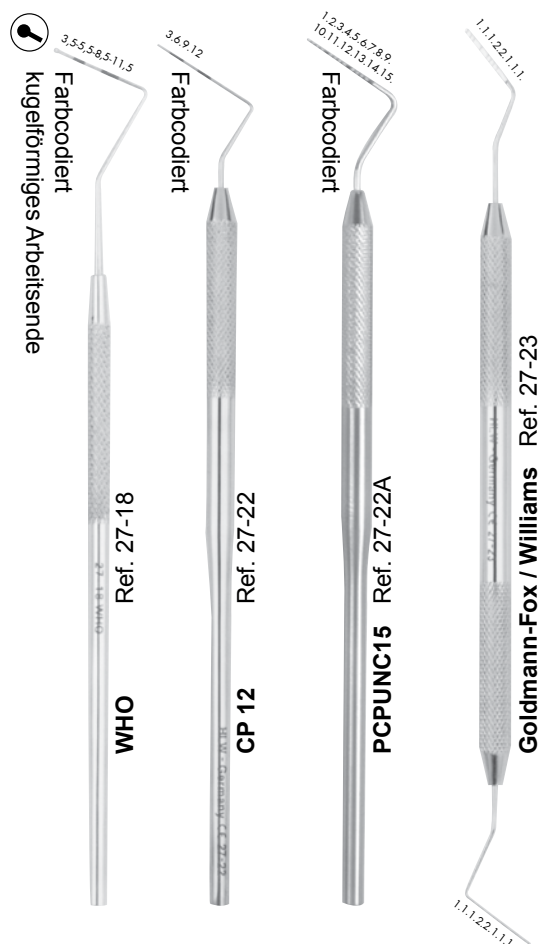

SCHARFE LÖFFEL



NADELHALTER - TC

TC =Tungsten Carbide

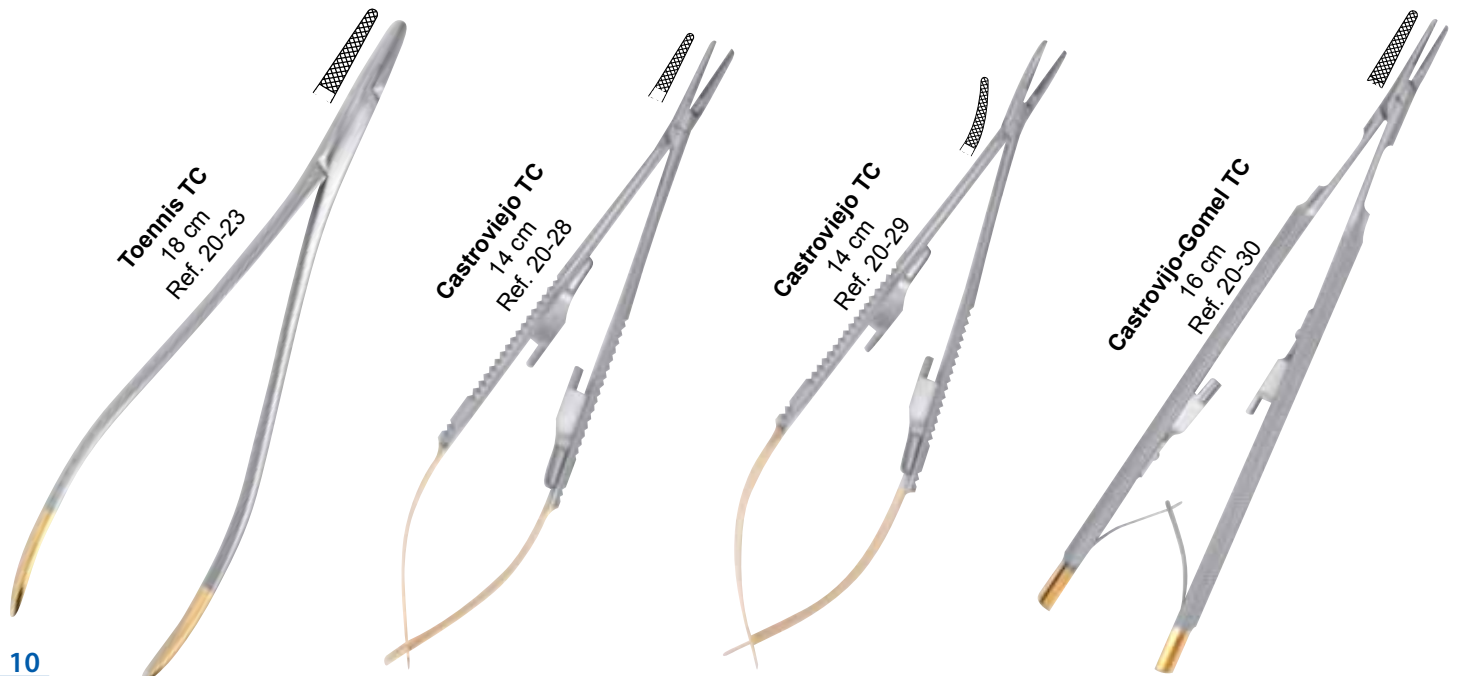
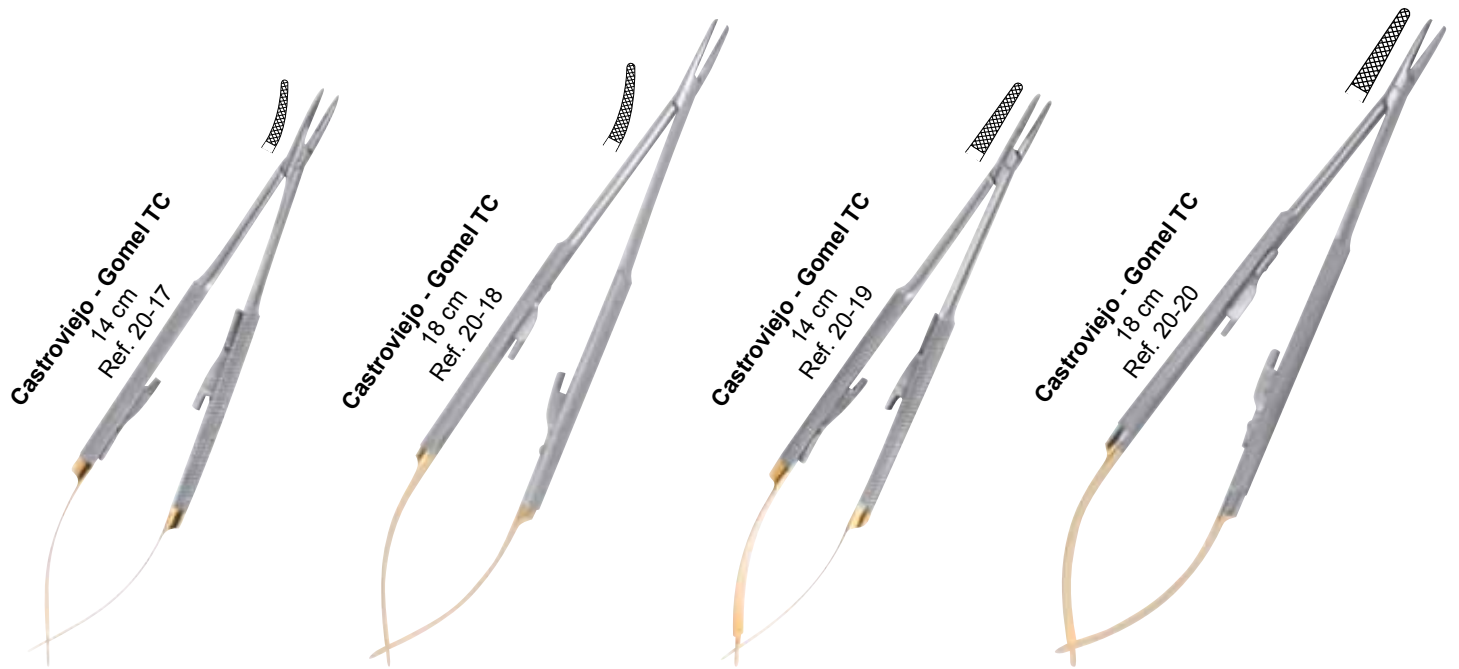

NADELHALTER

Halstead-Mosquito
gerade 12,5 cm
Ref. 20-1

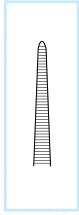

Halstead-Mosquito
gebogen 12,5 cm
Ref. 20-2

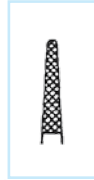
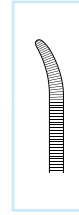

Castroviejo
14 cm
Ref. 20-16



Mathieu
14 cm
Ref. 20-13



NADELHALTER - TC



gerade
straight



Mayo-Hegar TC
16 cm
Ref. 20-25
Ref. 20-25M



M =
Microversion



gerade
straight



Mayo-Hegar TC
18 cm
Ref. 20-25AM

SCHEREN - TC

TC =Tungsten Carbide

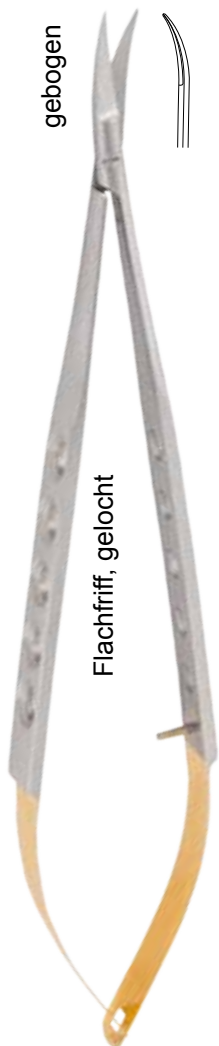

Micro Schere TC
17 cm
Ref. 19-23 B



Micro Schere TC
17 cm
Ref. 40-48 B

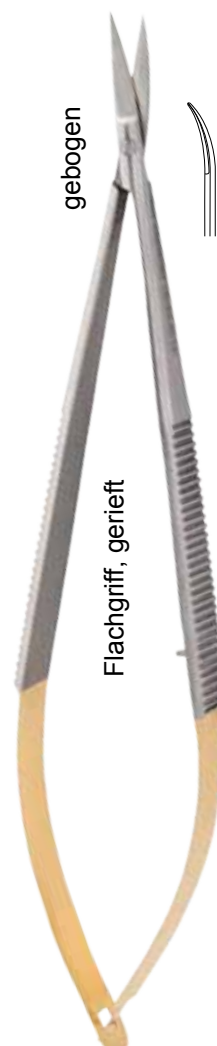

Castroviejo TC
14 cm
Ref. 19-23 TC



Castroviejo-Gomel TC
14 cm
Ref. 19-28 TC

SCHEREN - SUPERCUT

Die HLW SUPER-CUT Scheren zeichnen sich an einer Seite der Schneide, durch einen Spezialschliff und an der gegenüberliegenden Schneide, durch eine Micro-Zahnung aus.

The HLW SUPER-CUT Scissors has two different cutting blades - one with razor sharp edge and the other with micro-serrations.



gebogen

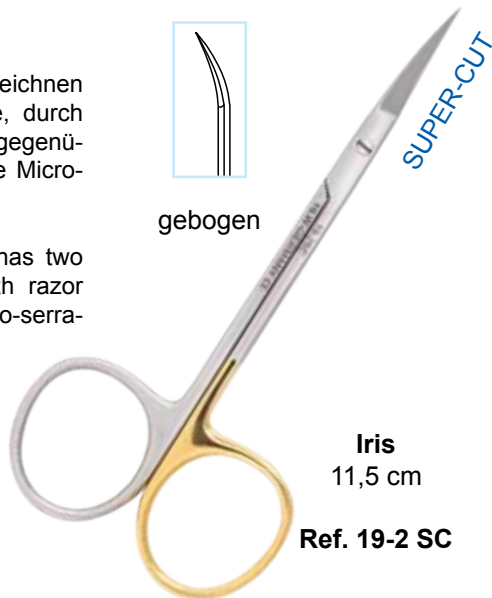

Iris
11,5 cm
Ref. 19-2 SC



doppelt gebogen

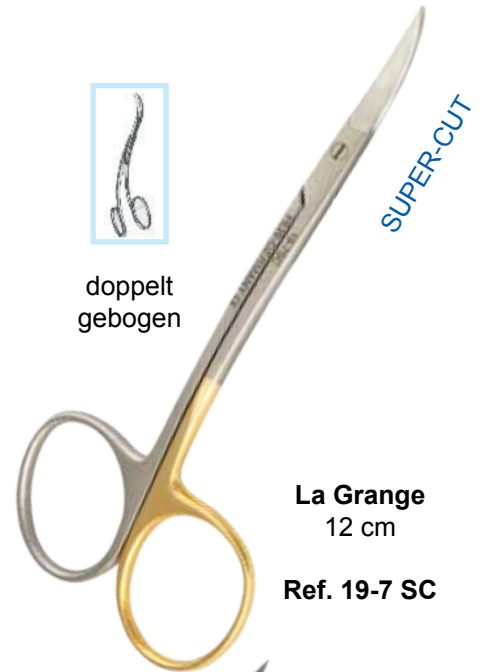

La Grange
12 cm
Ref. 19-7 SC



gebogen



Goldmann-Fox
13 cm
Ref. 19-6 SC

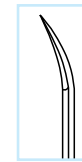

gebogen



Kelly
16 cm
Ref. 19-15 SC

SPREADING TYPE

Iris-gerade
11,5 cm

Ref. 19-1 SCS



Iris-gebogen
11,5 cm

Ref. 19-2 SCS



**Goldmann-Fox
doppelt gebogen**
12,5 cm

Ref. 19-6 SCS



SCHEREN

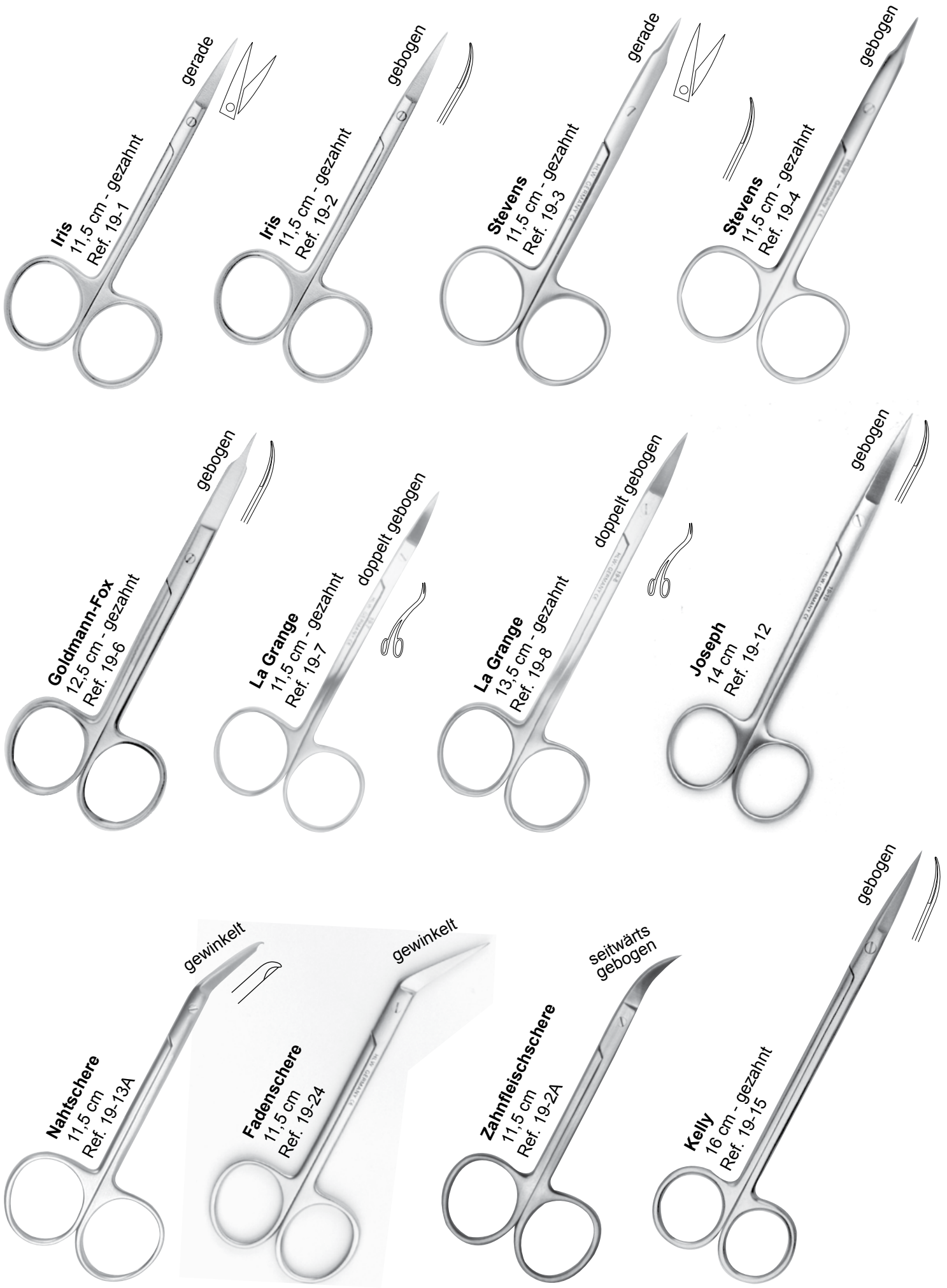

P.A. SCALER

CLASSIC (Ø 10 mm)



Taylor Fig. T2/3 Ref. 26-11A



Hygienist Fig. H6/H7 Ref. 26-19A



Fig. 204S Ref. 26-56A



Fig. 204SD Ref. 26-57A



McCall Fig. 13S/14S Ref. 26-14A

DELUXE (Ø 10 mm)



Taylor Fig. T2/3 Ref. 26-11B



Hygienist Fig. H6/H7 Ref. 26-19B



Fig. 204S Ref. 26-56B



Fig. 204SD Ref. 26-57B



Fig. M23 Ref. 26-62B



McCall Fig. 13/14 Ref. 26-15B

Knochenfeile
Hohlgriff Ø 10 mm extra leicht
Schugger Ref. 26-65



Gingivektomiemesser
Kirkland Fig. 15/16 Ref. 26-27



SINUS - ELVATOREN



Teller-Elevator mit Skalierung Ref. 40-S001



Sinus-Elevator Ref. 40-S002



Sinus-Elevator Ref. 40-S003



Sinus-Elevator Ref. 40-S004



PERIOTOME



PT01 Ref. 26-60

Zur atraumatischen Ex-
traktion von Implantaten,
schont Weichgewebe und
Knochen.



PT02 Ref. 26-61

IMPLANTATPINZETTE



Dieses Instrument ist die optimale Hilfe zum Gebrauch von allen Micro-Schraubensystemen in der Implantologie. Es fasst den Schraubenzieher perfekt und ermöglicht punktgenaues platzieren der Schrauben auch weit im Molarenbereich. Für alle gängigen Systeme.

∅ 1,3 mm Ref. 40-43
∅ 1,9 mm

Zur interoralen Plazierung von Abutments.

∅ 3,0 mm Ref. 40-43A

Haltepinzette TITAN

mit Schloss

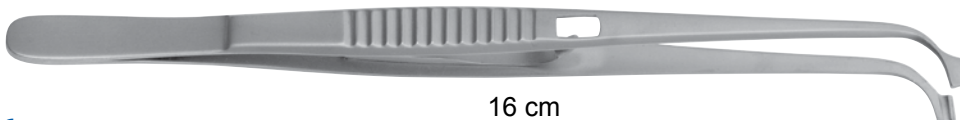

Ref. 40-43B

16 cm



IMPLANTOLOGIE INSTRUMENTE

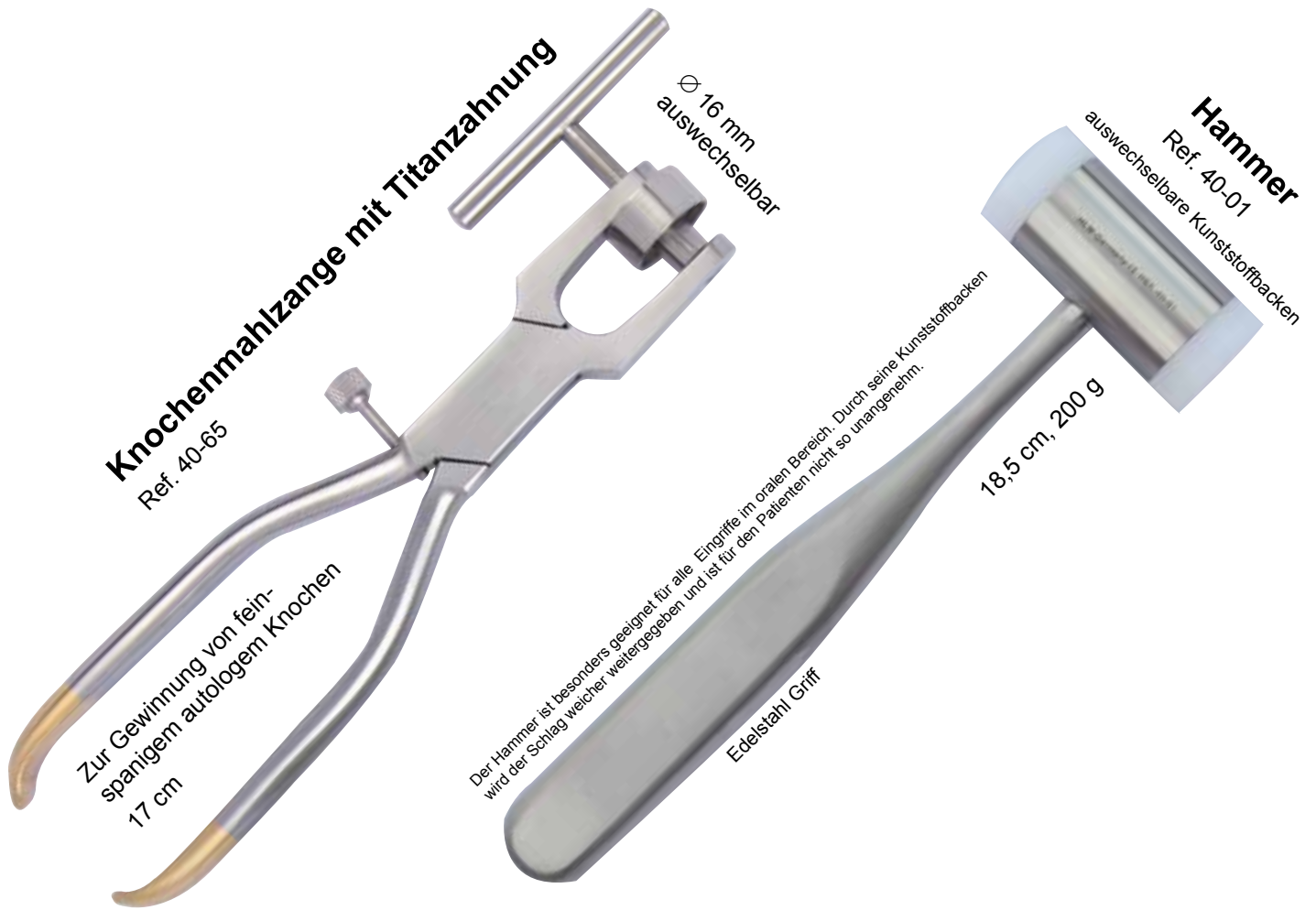

Ersatzfilter

Ref. 40-58A



Silikonfilter (sterilisierbar)
10er Pack

Knochenfalle / Absaugkanüle

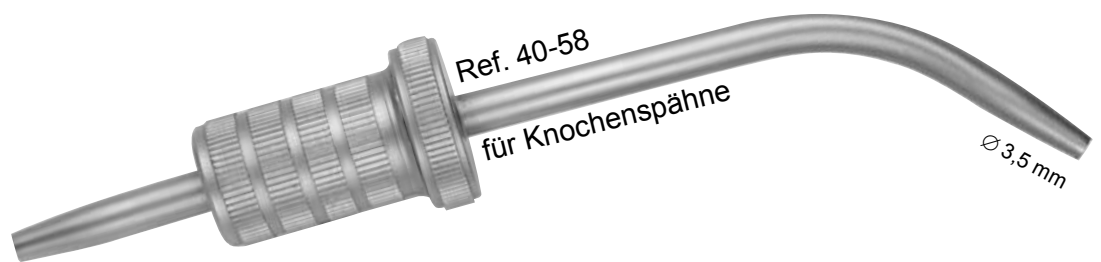

Chirurgische Absaugkanülen

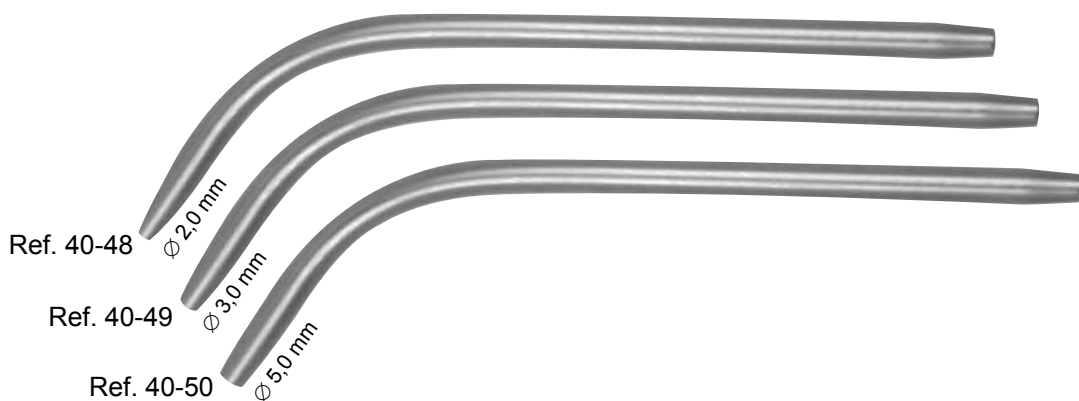

ABDRUCKKLÖFFEL SOLIDE

Oberkiefer / Upper

Größe/Size

XL



Ref-No.

Ref-No.
33-06

L



Ref-No.
33-07

M



Ref-No.
33-08

S



Ref-No.
33-09

XS



Ref-No.
33-10

XXS



Ref-No.
33-30

Unterkiefer / Lower

Größe/Size

XL



Ref-No.

Ref-No.
33-01

L



Ref-No.
33-02

M



Ref-No.
33-03

S



Ref-No.
33-04

XS



Ref-No.
33-05

XXS



Ref-No.
33-25

ABDRUCKKLÖFFEL PERFORIERT

Oberkiefer / Upper

Unterkiefer / Lower

Größe/Size

Ref-No.

Größe/Size

Ref-No.

XL



Ref-No.
33-16

XL



Ref-No.
33-11

L



Ref-No.
33-17

L



Ref-No.
33-12

M



Ref-No.
33-18

M



Ref-No.
33-13

S



Ref-No.
33-19

S



Ref-No.
33-14

XS



Ref-No.
33-20

XS



Ref-No.
33-15

XXS



Ref-No.
33-40

XXS



Ref-No.
33-35

EDELSTAHL WASHTRAYS

- auswechselbare Silikoneinsätze in 4 Farben
- Silikoneinsätze verschiebbar
- abnehmbarer Verschlussdeckel



Edelstahltray (5 Instrumente)

Maße:
184 x 74 x 34 mm
Ref. 15-51A



Edelstahltray (10 Instrumente)

Maße:
205 x 145 x 34 mm

Ref. 15-52

Silikoneinsätze für Wash Trays:

wie abgebildet

Farben:	 Orange	Ref. 15-50A
	 Grün	Ref. 15-50B
	 Gelb	Ref. 15-50C
	 Blau	Ref. 15-50D

